

ETHYLENE-DETECTOR I2096EL FOR EX-ZONE 2

Designed to meet with light industrial requirements, the I2096AC gas detectors allows monitoring flammable contents in areas classified as zone 2, category 3.

Ideal in light industrial environments the gas detector feature one man calibration via calibration keypad.

The detectors is IP65 protected and SIL2 Hardware tested (not certified) and provides a simple concept to replace sensors.

As an option the gas detectors is also available with a display.

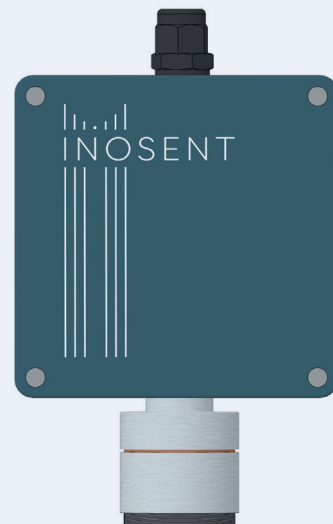

SPECIFICATIONS ELECTRONICS

SUPPLY: 24 VDC | **POWER CONSUMPTION:** max. 130 mA | **WIRING ANALOGUE/DIGITAL:** 3×0,75 mm² up to 100 m, shielded, 2×2×0,75mm², shielded | **SIGNAL-OUTPUT ANALOGUE/DIGITAL:** 4...20 mA, Modbus RTU | **OPTIONAL RELAY OUTPUTS:** 1 or 3 | **WEIGHT:** 850...1200 gr | **ATEX CERTIFIED FOR:** II 3G

SPECIFICATIONS SENSOR

MEASURING PRINCIPLE: Pellistor | **MEASURING RANGE:** 0...100 % LEL C₂H₄

ACCURACY: +/- 2 % of measuring range | **RESPONSE TIME:** t₉₀: < 30 sec | **OPERATION TEMPERATURE:** -40 °C ...+60 °C | **HUMIDITY:** 20...90 % (non condensing) | **APPROX. LIFETIME AT 20°C:** > 5 years depending on application | **CALIBRATION:** It is necessary to inspect the gas detector every 6 month and to recalibrate it only if needed.

DIMENSIONS AND CONNECTIONS

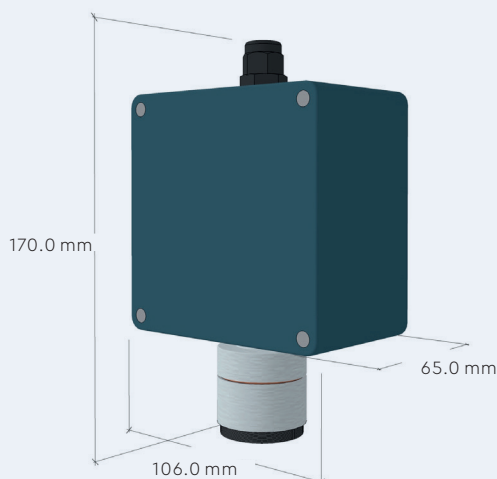

24VDC Bus1	2	3	4	5	6
BUS A	BUS B	0VDC	+ Analog	S Analog	
Ex-Gas Detector					