

GAS HEATING

INOSENT the brand for  
reliable gas detection systems.

INOSENT  
GASWARNTÉCHNIK AG

Eichwatt 5 | CH - 8105 Regensdorf / Switzerland  
Telephone: +41 (0)44 556 83 00 | Fax: +41 (0)44 556 83 01  
info@inosent.ch | www.inosent.ch

## COMPANY

### **WE ARE INOSENT**

Our products are defined by creativity along with constant development. Our goal is to always deliver our customers the best solution while striving to create an excellent enduring working relationship. Trust, fairness and dependability are our highest priorities. At Inosent, we are firmly convinced that the best solutions can only be found through loyal, courteous consultation and collaboration. At the same time, we are always open to new ideas and we enjoy exciting challenges. INOSENT is authentic, fair – and always there for you.

### **OUR CUSTOMERS ARE IMPORTANT TO US**

Our constant enthusiasm for our work is also the result of our belief in the value of genuine cooperation with our customers. We will give you honest advice that makes it possible for you to profit from our knowledge of the latest technical possibilities. Because, at the end of the day, even a technical field like gas detection technology is about human beings who are working with each other and for each other. And because of that, the honest relationship to our customers and the serious interaction with our customers is the most important thing for Inosent. INOSENT has time for you – and is always there for you.

### **WE LIKE TO FIND NEW PATHS**

The world is in constant change – and, in technical fields above all, it is important to meet new possibilities with enthusiasm and creativity. When safety is the primary objective, the continual development of systems and solutions work in tandem with this goal. That is why we, at Inosent, keep our enthusiasm for innovation, and work both creatively and carefully on new solutions that can better satisfy our customers' requirements. INOSENT has time for you – and is always there for you.

## AREAS OF APPLICATION

INOSENT the brand for reliable gas detection systems.

In the workplace, gas detection systems are an indispensable safety asset across a spectrum of industrial processes. Consider the routine daily use of gases in heating and refrigeration equipment in addition to the dangerous gaseous produced from processes such as, fermentation, incineration, engine combustion to name but a few. These gases can be explosive or toxic as

well as colourless, odourless and tasteless. Gases and their presence in ambient air must therefore, be accurately and professionally monitored continuously on a 24-hour basis.

INOSENT offers you intelligent, comprehensive solutions within a wide scope of industrial applications. We will support you with constructive and competent advice so that you can plan for the highest levels of safety.

### COOLING SYSTEMS



IN GENERAL, THE FOLLOWING GASES WILL BE MONITORED:

(H)FKW | HFO | C<sub>3</sub>H<sub>8</sub> | CO<sub>2</sub> | NH<sub>3</sub>

WE RECOMMEND:

- INOSENT EASY
- INOSENT ULTIMATE

### UNDERGROUND CAR PARK



IN GENERAL, THE FOLLOWING GASES WILL BE MONITORED:

CARBON MONOXIDE CO  
NITROGEN DIOXIDE NO<sub>2</sub>

WE RECOMMEND:

- INOSENT COMPACT
- INOSENT ULTIMATE

### GAS HEATING



IN GENERAL, THE FOLLOWING GASES WILL BE MONITORED:

METHANE CH<sub>4</sub> | PROPANE C<sub>3</sub>H<sub>8</sub>

WE RECOMMEND:

- INOSENT CLASSIC

### LABORATORY



IN GENERAL, THE FOLLOWING GASES WILL BE MONITORED:

O<sub>2</sub> | CO | H<sub>2</sub> | CO<sub>2</sub> | NH<sub>3</sub> | C<sub>3</sub>H<sub>8</sub>  
O<sub>3</sub> | SiH<sub>4</sub> | PH<sub>3</sub> | ECT.

WE RECOMMEND:

- INOSENT ULTIMATE

### INDUSTRY ATEX ZONE 1 & 2 SIL 1 & SIL 2



IN GENERAL, THE FOLLOWING GASES WILL BE MONITORED:

NH<sub>3</sub> | SOLVENTS | C<sub>3</sub>H<sub>8</sub>  
CH<sub>4</sub> | H<sub>2</sub> | ECT.

WE RECOMMEND:

- INOSENT PREMIUM
- INOSENT ULTIMATE

## PRODUCT LINES

### E A S Y



A simple, very high-quality, stand-alone compact solution for small systems:

24 VDC/AC or 230 VAC | LED status display | 85 dB-Alarm Horn  
2 Relay outputs | 4-20mA, 0-10VDC, Modbus RTU | IP 65 Protected

### C O M P A C T



The ideal solution for monitoring CO and NO<sub>2</sub> as well as humidity in underground garages:

24 VDC | 16 BUS-Inputs for gas detectors and alarm lights | 4 x 4-20mA-Input | LCD-Display | 8 Digital outputs | Output 0-10VDC, Modbus RTU

### C L A S S I C



Efficient gas monitoring monitor in a wall-mounted housing for 2, 4 or 6 gas detectors:

24 V DC/AC or 230 VAC | 2, 4 or 6 x 4-20mA-Input | LCD-Display  
4 Relay outputs | IP 65 Protected | incorporated data logger

### U L T I M A T E



A versatile, intelligent gas detection system with an innovative visual display of parameters on a touch screen:

24 VDC | 90 Inputs for gas detectors, alarm lights and accessories | 7" Touch-Display | USB/ RJ45-Connection | 8 Relay outputs, expandable  
Modbus RTU/TCP outputs, optional 0-10VDC or 4-20mA

### P R E M I U M



A powerful, multi-functional gas detection system specially designed for SIL1 or SIL2 systems:

24 VDC | 256 Inputs for gas detectors (BUS or 4-20mA)  
LCD-Display | 8 Relay outputs, expandable | 19"-Rack or metal box  
incorporated data logger

### P O R T A B L E



**Blackline Safety:** Wide range of gas sensors and accessories.  
Alarm forwarding with location information by e-mail and SMS.

**Riken Keiki:** Mobile single-gas and multi-gas devices, extremely robust, smallest and lightest five-gas meter in the world.

## GAS HEATING

When using gas heaters, liquefied propane gas (propane/ $C_3H_8$ ) and natural gas (methane/ $CH_4$ ) must be carefully monitored on a 24 hour basis. Because their use may result in dangerous gas leaks that must be immediately reported and stopped. Gas leaks caused by wear and vibration can be very dangerous, and the danger can be mitigated by using the correct gas detection system.

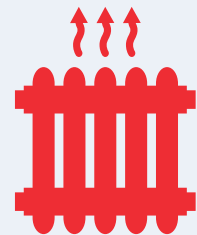

INOSENT RECOMMENDS THE «**CLASSIC**» PRODUCT LINE FOR BOILER PLANT ROOMS.

For monitoring natural gas or liquefied propane, the «**CLASSIC**» product line is ideal: The programmable, self-monitoring gas monitor gives an alarm when upper and lower boundary values are exceeded. The alarm consists of a central flashing light and/or an alarm horn. In addition to the alarm, the gas flow will be stopped by closing a solenoid valve on the gas line, the burner turned off and the ventilation switched on.

The gas detectors are available with and without a display. Gas detectors are also available for use in explosion zones 1 and 2; for indoors applications, the detectors are also available in a white plastic housing. However, the gas detectors, which are not explosion-proof, have, as standard equipment, an optical and acoustical alarm indicator and can also be used without a gas monitor.

SIMPLE, CLEAR-CUT, AND IDEAL FOR GAS HEATERS:  
THE «**CLASSIC**» PRODUCT LINE



- RELIABLE MONITORING OF METHANE AND PROPANE
- THE CONTROL PANEL «CLASSIC»
- GAS DETECTORS FOR MONITORING OF  $CH_4$  AND  $C_3H_8$ ; OTHERS CAN BE CONNECTED
- FLASHING LIGHT

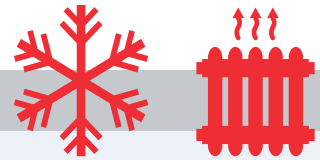

## INOSENT CLASSIC

STANDARD - ANALOGUE SYSTEM

**SIGNAL:**

4 - 20 mA

**MAX. QUANTITY GAS DETECTORS:**

2 OR 4

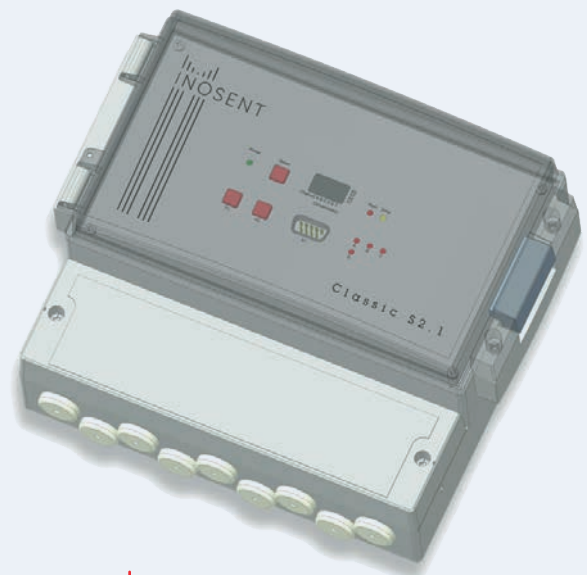

— SUPPLY TO GAS DETECTORS:  
3 × 0,75 mm<sup>2</sup>, shielded, max. 1000 m

— SUPPLY TO ALARM UNITS:  
24 VDC or 230 VAC

**AREA:**  
E.G. BOILER PLANT

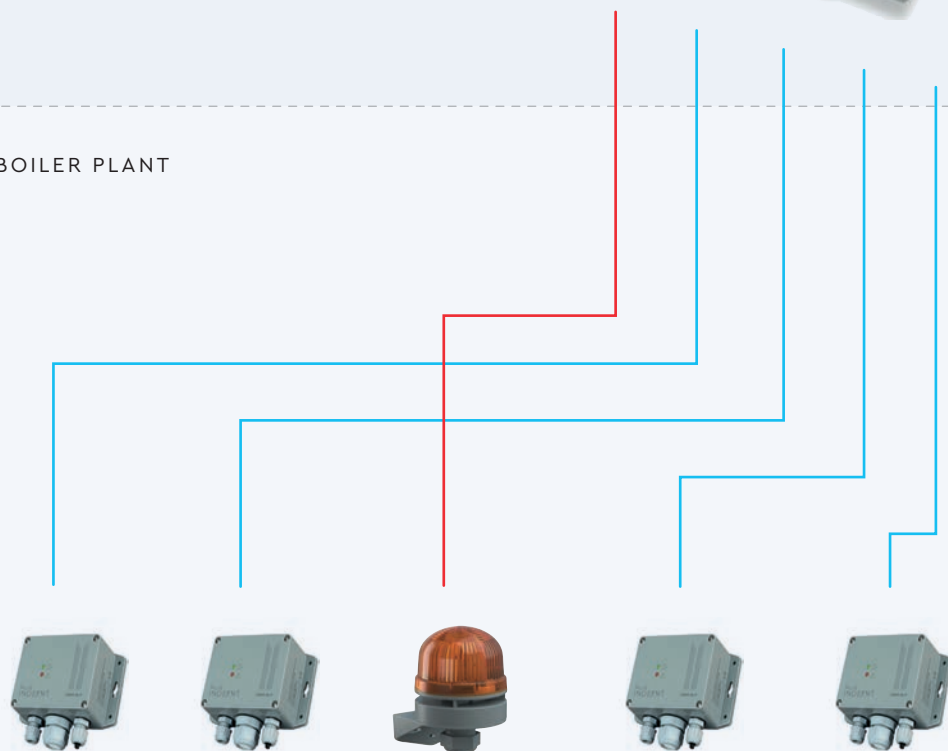

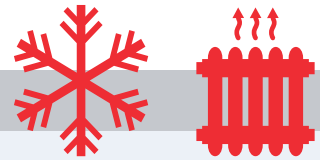

## CLASSIC S2.1 / S4.1

The Classic product line is an efficient gas monitor in a wall-mounted housing for 2 or 4 detectors. It is used to monitor the concentration levels of gases and vapours. The alarm is triggered when pre-programmed alarm levels are exceeded. The Classic product line has a built-in data logger and connectors for different detectors.

The Classic product line can easily be programmed using the PC. Using potential-free relay outputs, devices such as solenoid valves or flashing lights can be activated.

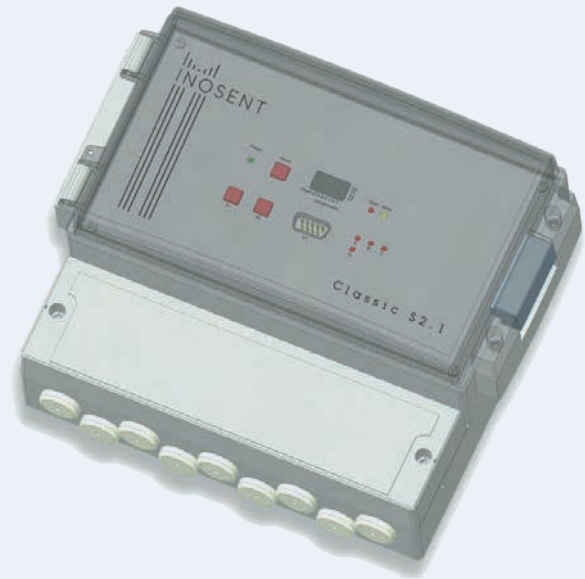

### OVERVIEW:

- 2 YEARS WARRANTY
- CONVENIENT WALL MOUNTING
- PROGRAMMING USING PC
- DISPLAY OF MEASURING RANGES, ALARM LEVELS AND ALARM GROUPS

### TECHNICAL SPECIFICATIONS

**SUPPLY VOLTAGE:** 24 VDC/AC or 230 VAC | LED status display for operational status and malfunctions | LED alarm display for pre-alarm and main alarm | Protection level IP 65 | 4 built-in relay contacts | **SIGNAL INPUT:** 2 (S2.1) or 4 (S4.1) x 4-20mA

### DIMENSIONS AND CONNECTIONS

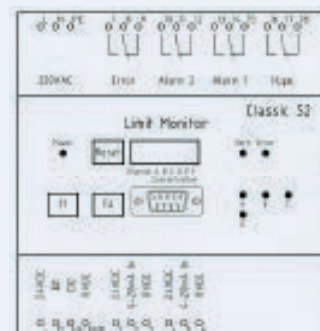
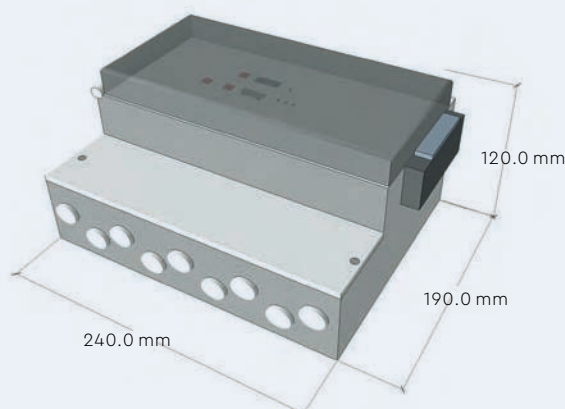

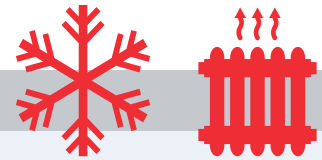

## CLASSIC TS4.1 / TS6.1

The Classic product line is an efficient gas monitor for mounting on a top hat rail for 4 oder 6 detectors. It is used to monitor the concentration levels of gases and vapours. The alarm is triggered when pre-programmed alarm levels are exceeded. The Classic product line has a built-in data logger and connectors for different detectors.

The Classic product line can easily be programmed using the PC. Using potential-free relay outputs, devices such as solenoid valves or flashing lights can be activated.

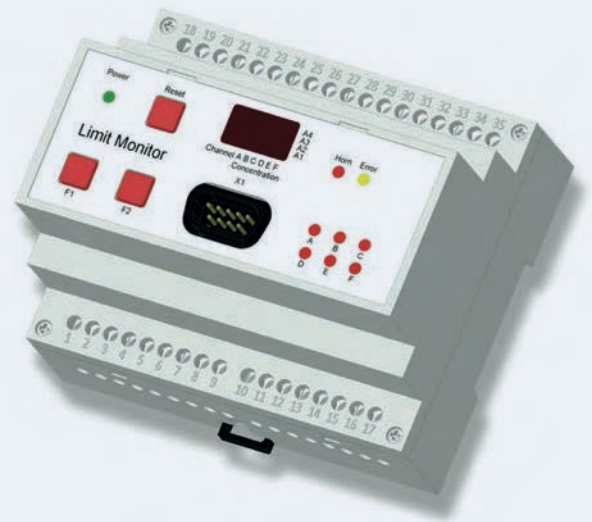

### OVERVIEW:

- 2 YEARS WARRANTY
- CONVENIENT TOP HAT RAIL MOUNTING
- PROGRAMMING USING PC
- DISPLAY OF MEASURING RANGES, ALARM LEVELS AND ALARM GROUPS

### TECHNICAL SPECIFICATIONS

**SUPPLY VOLTAGE:** 24 VDC | LED status display for operational status and malfunctions | 4 (TS4.1) or 6 (TS6.1) built-in relay contacts (normally closed contacts), 250 VAC, 1 A | LED alarm display for pre-alarm and main alarm | Protection level IP 20 | **SIGNAL INPUT:** 4 (TS4.1) or 6 (TS6.1) x 4-20mA

### DIMENSIONS AND CONNECTIONS

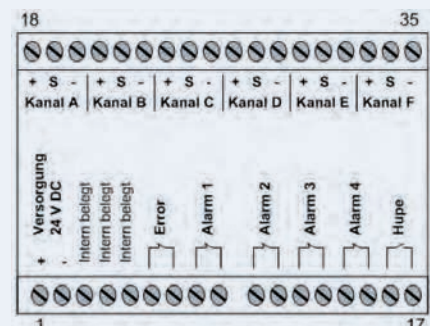
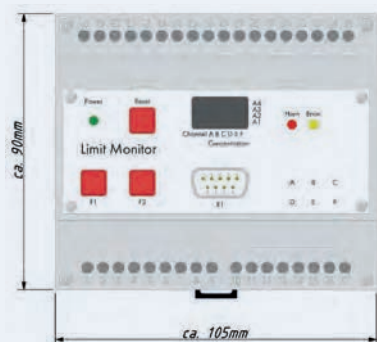



IP65



## METHANE-DETECTOR I2608-CH4-S

The Gas detector is designed for the detection of Methane CH<sub>4</sub> and provides 2 internal relay outputs for ventilation control and alarm, a 85 dB Alarm buzzer and an LED alarm indicator. The Gas detector provides analogue (4-20mA and 0-10VDC) and digital (Modbus RTU) output signals. The supply of the gas detector is 24 VDC or 230 VAC and can also be operated „stand-alone“ without any gas monitor. The light grey ABS plastic enclosure is IP 65 protected and the internal sensor can be easily replaced when its life time is over. Optionally the Gas detector is also available with an remote sensor, integrated display or in a neutral IP20 enclosure for Indoor-Installation.



### SPECIFICATIONS ELECTRONICS

**SUPPLY:** 11...30 VDC/VAC (optional 90...265 VAC) | **POWER CONSUMPTION:** max. 60 mA  
**WIRING ANALOGUE/DIGITAL:** 3×0,75 mm<sup>2</sup>, shielded, 2×2×0,75 mm<sup>2</sup>, shielded | **SIGNAL-OUTPUT ANALOGUE/DIGITAL:** 4...20 mA, 0...10VDC, Modbus RTU | **RELAY OUTPUTS:** 2 SPST (250 VAC/ 30 VDC, 5A max) | **WEIGHT:** 500 gr | **CERTIFICATES:** CE

### SPECIFICATIONS SENSOR

**MEASURING PRINCIPLE:** Semiconductor | **MEASURING RANGE:** 0...100 % LEL | **ACCURACY:** +/- 3 % of measuring range | **RESPONSE TIME:** t<sub>90</sub>: < 15 sec | **OPERATION TEMPERATURE:** -40 °C ...+70 °C  
**HUMIDITY:** 0...95 % (non condensing) | **SIGNAL DRIFT:** < 1% Signal/Month  
**APPROX. LIFETIME:** > 5 years, depending on applicaton | **CALIBRATION:** It is necessary to recalibrate the gas detector at least once a year.

### DIMENSIONS AND ELECTRONICS

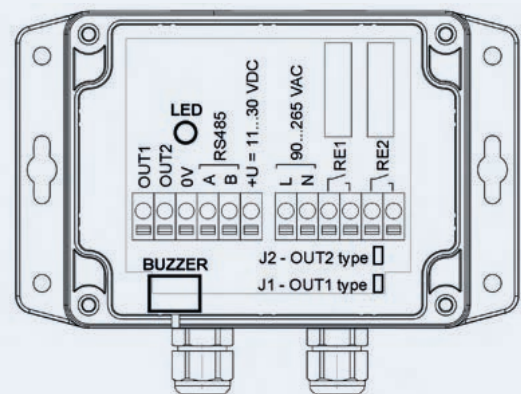
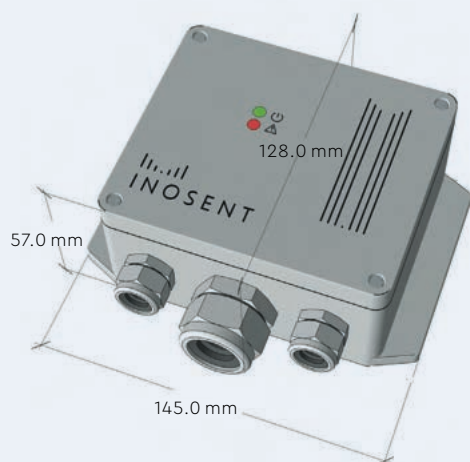

IP65



## PROPANE-DETECTOR I2608-C3H8-P

The Gas detector is designed for the detection of Propan C<sub>3</sub>H<sub>8</sub> and provides 2 internal relay outputs for ventilation control and alarm, a 85 dB Alarm buzzer and an LED alarm indicator. The Gas detector provides analogue (4-20mA and 0-10VDC) and digital (Modbus RTU) output signals. The supply of the gas detector is 24 VDC or 230 VAC and can also be operated „standalone“ without any gas monitor. The light grey ABS plastic enclosure is IP 65 protected and the internal sensor can be easily replaced when its life time is over. Optionally the Gas detector is also available with an remote sensor, integrated display or in a neutral IP20 enclosure for Indoor-Installation.



### SPECIFICATIONS ELECTRONICS

**SUPPLY:** 11...30 VDC/VAC (optional 90...265 VAC) | **POWER CONSUMPTION:** max. 60 mA |  
**WIRING ANALOGUE/DIGITAL:** 3×0,75 mm<sup>2</sup>, shielded, 2×2×0,75 mm<sup>2</sup>, shielded | **SIGNAL-OUTPUT ANALOGUE/DIGITAL:** 4...20 mA, 0...10VDC, Modbus RTU | **RELAY OUTPUTS:** 2 SPST (250 VAC/ 30 VDC, 5A max) | **WEIGHT:** 500 gr | **CERTIFICATES:** CE

### SPECIFICATIONS SENSOR

**MEASURING PRINCIPLE:** Pellistor | **MEASURING RANGE:** 0...100 % LEL | **ACCURACY:** +/- 3 % of measuring range | **RESPONSE TIME:** t<sub>90</sub>: < 15 sec | **OPERATION TEMPERATURE:** -40 °C ...+70 °C  
**HUMIDITY:** 0...95 % (non condensing) | **SIGNAL DRIFT:** < 1% Signal/Month |  
**APPROX. LIFETIME AT 20°C:** > 5 years, depending on application | **CALIBRATION:** It is necessary to recalibrate the gas detector at least once a year.

### DIMENSIONS AND ELECTRONICS

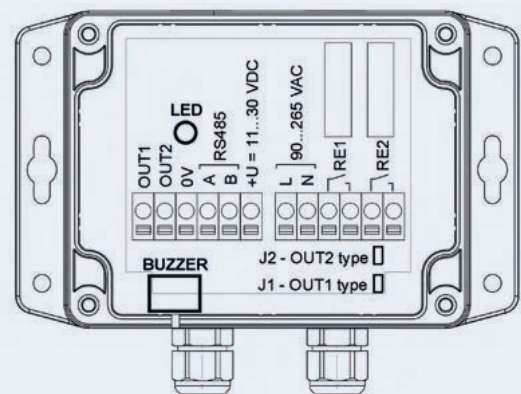
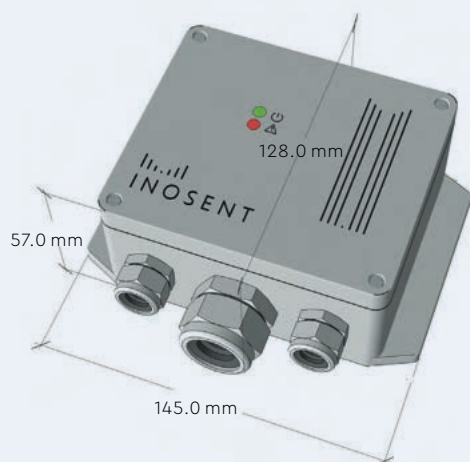

## ALARM LIGHT WITH HORN TYPE I94-230

Horn with flashing light in current technology without mechanical wear parts. 2 different sound variants selectable by means of a toggle switch. Separate control of the light and the horn possible. Standard colour yellow.

### SPECIFICATIONS

**SUPPLY VOLTAGE:** 230 VAC  
**POWER:** max. 60mA  
**WIRING:** 2x0,75 mm  
**PROTECTION CLASS:** IP 66 (ABS-CASE)  
**VOLUME:** 95 dB  
**SOUNDS:** 2 sounds variants  
**LIGHTNING:** 0,7Ws 1 Hz  
**OPERATING TEMPERATURE:** -30...+60 °C  
**DIMENSIONS:** height 85mm, diameter 62mm  
**WEIGHT:** 78 gr  
**CERTIFICATIONS:** CE



### DIMENSIONS

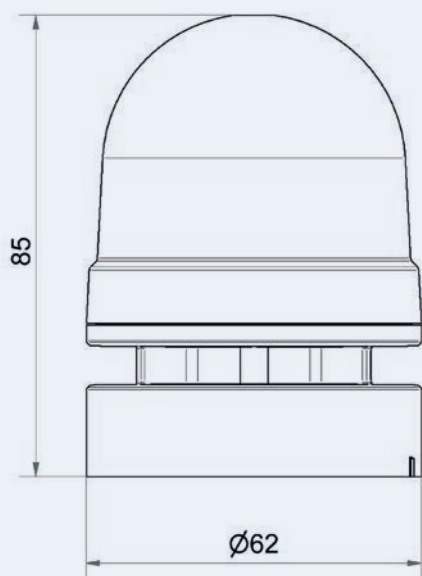

### CONNECTIONS

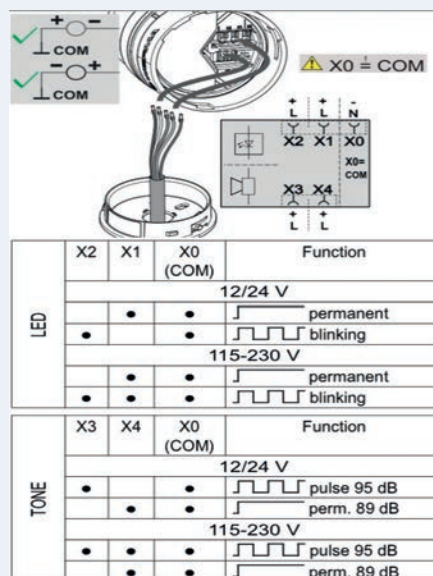

## LED-WARNING SIGN WITH HORN TYPE I30 (BUS-COMPATIBLE)

The 30 cm long LED-Sign with bright red LED's may be used for most types of Gas Alarm. The LED-Sign can be used with a flashing or a continuous light and includes the option to pre-select text or pictograms in different colours, depending on the client's request. The supply voltage of the LED-Sign is 24VDC and it incorporates a 92dB Alarm horn, which can be controlled separately from the LED's.

The LED-Sign in combination with the INOSENT BUS-compatible 'Ultimate' or 'Compact' controller allows for independent programming of the LED's and sounder in different alarm modes. This design function facilitates a simple installation on the same BUS-Cable as the gas detectors, eliminating the need for additional cable. The LED-Sign is also available with 60 cm length one sided (standard) or double-sided.



### LED-SIGN (ELECTRONICS)

**SUPPLY VOLTAGE:** 24 VDC | **POWER :** max. 2 W | **SUPPLY ANALOGUE (24V)/DIGITAL:** 2x 0,75 mm, 2x2x0,75 mm<sup>2</sup>, shielded | **PROTECTION CLASS:** IP 52 | **VOLUME:** ca. 92 dB | **LIFETIME LEDS:** 50'000 h | **WEIGHT:** 400 gr | **CERTIFICATIONS:** CE

### DIMENSIONS AND CONNECTION

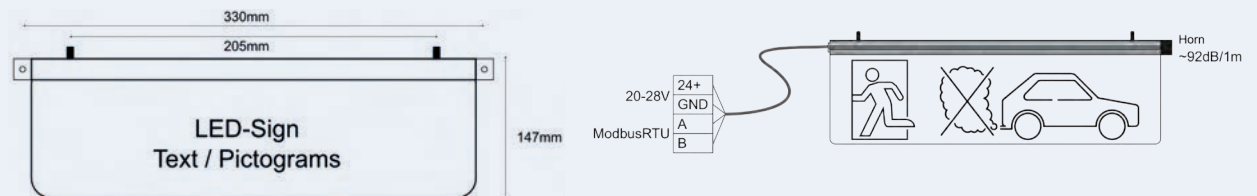

## CONTACT

### **INOSENT IS THERE FOR YOU**

Regardless of the reason for your interest in the area of gas detection technology: Contact us and we will do our best to find the optimum solution for you.

We will be happy to go into detail with you and address your specific ideas and concerns – because you can always depend on INOSENT.

INOSENT Gaswarntechnik AG

Eichwatt 5  
CH-8105 Regensdorf / Switzerland

Telephone: +41 (0)44 556 83 00

Fax: +41 (0)44 556 83 01

E-Mail: [info@inosent.ch](mailto:info@inosent.ch)